

# T&R Test Equipment Ltd

**TRUSTED & RELIABLE**

## OPERATING AND MAINTENANCE MANUAL

For software version 1.01

Product: **200A dc Digital Micro-ohmmeter**

Type: **DMO200**



*DESIGNED AND MANUFACTURED IN THE UK BY:*

**T & R Test Equipment Limited**

15-16 Woodbridge Meadows, Guildford, Surrey, GU1 1BJ, United Kingdom

Telephone: 01483 207428

Fax.: 01483 511229

e-mail:

Web:

[sales@trtest.com](mailto:sales@trtest.com)

[www.trtest.com](http://www.trtest.com)

## GENERAL SAFETY STATEMENT



### WARNING

The following safety precautions should be reviewed to avoid injury to the user and damage to the product (and other products connected to it). To avoid potential hazards only use this product as specified.

- **Only suitably qualified personnel should use this equipment. Servicing of this product should only be carried out by suitably qualified service personnel.**

### To Avoid Fire Hazards and Personal Injury

- Use the correct power supply lead. Only use a suitably rated and approved power supply lead for the country of use.
- Ensure that systems that the unit is to be connected to are dead.
- Do not connect and disconnect leads whilst outputs are switched on. Breaking the output circuit with current flowing may cause arcing.
- Ensure that the product is grounded. To avoid electric shock it is essential that the grounding conductor is connected to the earth ground. An additional earth terminal is provided on the unit that must be connected to a local earth. Ensure that the unit is properly grounded before making any connections to inputs or outputs.
- Terminal ratings must be observed to prevent fire hazards and risk of injury to the operator. Consult the product manual for ratings information before making connections to any terminal.
- It is **ESSENTIAL** to consult the product manual for rating information before making any connection to a terminal or terminal group marked with a warning triangle.
- Only use fuses of a type and rating specified for this product.
- Do not operate the unit out of its case or with any covers or panels removed.
- Do not touch exposed connections and components when power is present.
- Do not operate the product if any damage is suspected. Refer the unit to qualified service personnel to be checked.
- Do not operate the unit in wet or damp conditions
- Do not operate the unit in an explosive atmosphere
- The DMO200 has a high dc output current (up to 200A), and therefore generates large magnetic fields around the output leads. Care must be taken in siting the unit next to items sensitive to magnetic fields (such as computer monitors and other sensitive equipment).
- Warnings from cardiac pacemaker manufacturers state that strong magnetic fields may affect operation. Any high current unit such as the DMO200 should therefore not be operated by, or in the vicinity of persons fitted with cardiac pacemakers or any other electronic or electrical medical implants.

If any further queries occur regarding the usage and maintenance of the equipment detailed in this manual, please refer these to the supplier of the equipment in the first case or to the manufacturer, T & R Test Equipment Limited.

## SAFETY TERMS AND SYMBOLS

The following safety symbols appear on the equipment:



CAUTION/WARNING – Refer to manual



Mains off



Mains on

The following safety symbols appear in this manual:



CAUTION

This action or procedure may be dangerous if not carried out correctly, and may cause damage to the equipment or connected equipment.



WARNING

This action or procedure may cause injury or death to the operator or other personnel if not carried out correctly using applicable safety procedures.



# CONTENTS

<b>1.</b>	<b>DESCRIPTION OF EQUIPMENT</b>	<b>7</b>
<b>1.1</b>	<b>Connections, controls &amp; display</b>	<b>8</b>
1.1.1	Front panel controls	8
1.1.2	Display	10
1.1.3	Warning messages	11
<b>1.2</b>	<b>Outputs and inputs</b>	<b>11</b>
1.2.1	Main output	11
1.2.2	Sense voltage input	12
1.2.3	Resistance ranges	12
<b>1.3</b>	<b>Installation</b>	<b>13</b>
1.3.1	Environment	13
1.3.2	Supply requirements	13
1.3.3	Connection cable ratings	13
1.3.4	Overload protection	13
<b>2.</b>	<b>OPERATION</b>	<b>15</b>
<b>2.1</b>	<b>Principle of operation</b>	<b>15</b>
<b>2.2</b>	<b>Connections</b>	<b>16</b>
<b>2.3</b>	<b>Method of operation</b>	<b>17</b>
2.3.1	Connection of leads	17
2.3.2	Switching on	17
2.3.3	Taking a measurement	17
2.3.4	Setting a custom test current	18
2.3.5	Storing a custom current as a preset	18
2.3.6	Reversed sense leads	18
<b>2.4</b>	<b>Data storage</b>	<b>19</b>
2.4.1	Entering a comment	20
2.4.2	Storing additional readings	20
2.4.3	USB memory key folders and files	20
<b>2.5</b>	<b>Result printer</b>	<b>20</b>

<b>2.6</b>	<b>DMO200 limit functions</b>	<b>21</b>
2.6.1	Setting Limits	21
2.6.2	Operation	22
<b>2.7</b>	<b>Current clamp for operation with both sides grounded</b>	<b>23</b>
2.7.1	Probe details (T&R Test A224-0001 probe)	24
2.7.1	Probe connection and setup	25
2.7.2	Enabling the probe	26
2.7.3	Operation	27
<b>3.</b>	<b>MAINTENANCE</b>	<b>28</b>
<b>4.</b>	<b>ACCESSORIES</b>	<b>29</b>
4.1	Standard accessories supplied with the DMO200	29
4.2	Optional accessories	30
<b>5.</b>	<b>OVERALL PERFORMANCE SPECIFICATION</b>	<b>31</b>
5.1.	Insulation resistance at 1000V DC	31
5.2.	Applied voltage test	31
5.3.	Accuracy of instrumentation and associated circuit components	31
<b>6.</b>	<b>REVISION</b>	<b>33</b>

# 1. DESCRIPTION OF EQUIPMENT

The DMO200 is a high current micro-ohmmeter designed for the measurement of very low resistances. Resistances down to  $0.1\mu\Omega$  can be measured at 200A and up to  $5\Omega$  at 1A. The DMO200 has pre-settable output current and electronic current control. Resistance is measured using the four wire method to remove the effect of the lead resistances. Current is injected using a pair of high current leads and the voltage drop across the resistance to be measured is picked up with sense connections. In addition, an optional current clamp may be connected to monitor any current lost to parallel connection paths (such as the earth current when testing large circuit breakers with safety earths connected to both sides of the breaker).

The unit has data storage facilities using a USB memory key, and comments can be entered to be stored with the results using a USB keyboard.

The unit has an easy to read liquid crystal display that shows all values (A, V and  $\Omega$ ) and programmable buttons to store 3 custom test currents (set to 50A, 100A and 200A by default).

The DMO200 must only be used on 'dead' systems (i.e. no externally supplied voltages are present on the test object. Do not connect the DMO200 to a live system. Always check that the device under test is isolated and earthed on at least one side before making any connections.

# 1.1 Connections, controls & display

## 1.1.1 Front panel controls

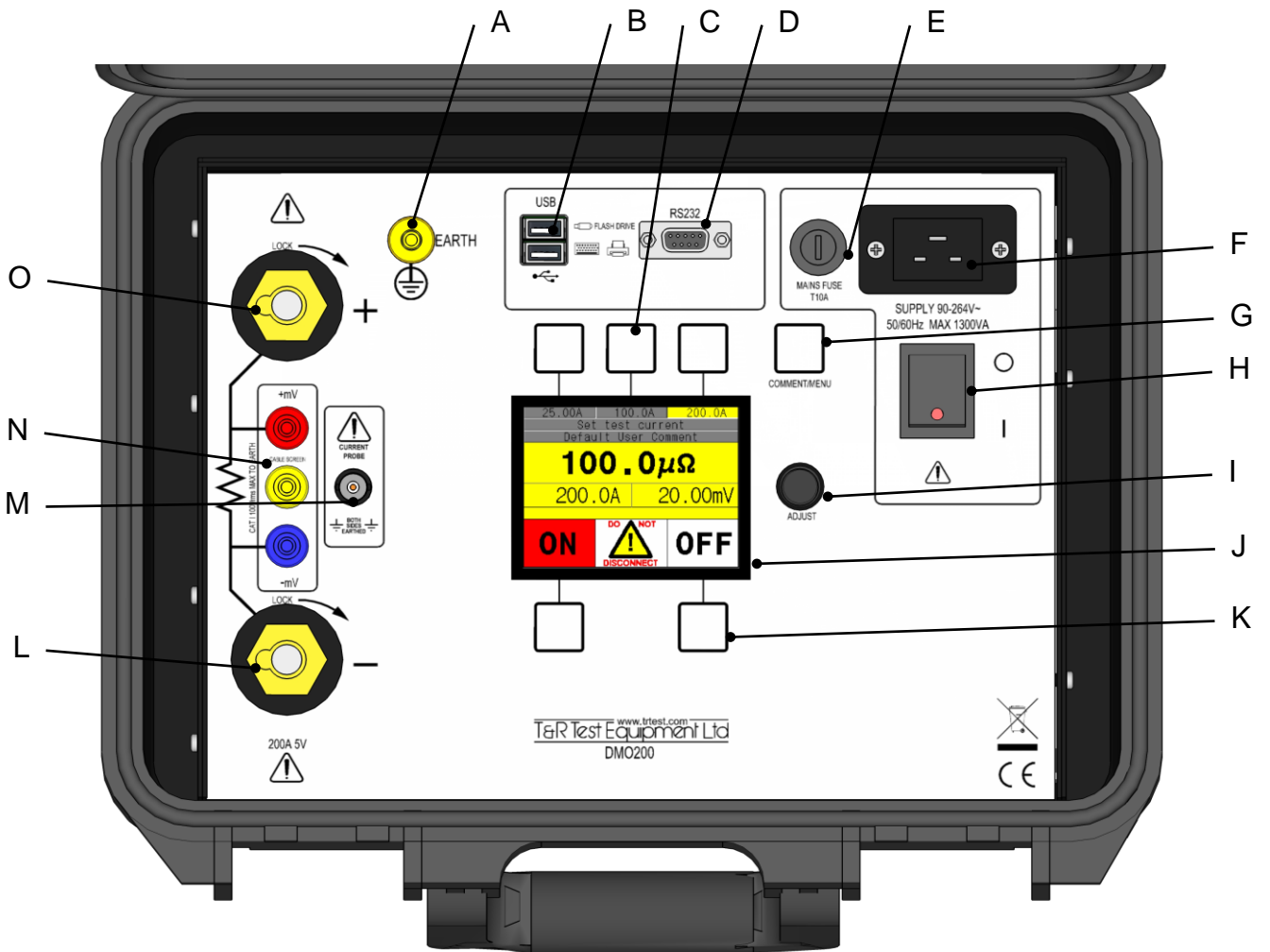

Figure 1.1 Front panel controls



A	Earth terminal	Extra safety earth to connect to local earth in substation environments. Use supplied green/yellow earth lead to connect to local earth.
B	USB sockets	Upper USB socket for connection of USB memory key. Lower USB socket for connection of keyboard or printer.
C	Test current select buttons	Store 3 commonly used test currents. Set to 50A, 100A and 200A by default.
D	RS232 interface	Serial interface for optional printer or control of unit.
E	Input fuse	Supply fuse T10A 32mm.
F	Mains supply connector	Connection for mains supply.
G	Comment/menu button	When the output is off, press briefly to change the comment to be stored with the next result. Hold for two seconds to enter menu mode.  With the output on, press to store the measurements on the display to the memory key.
H	Mains switch	Supply switch/mains on indicator
I	Adjust knob	Set the required test current/select menu entries/adjust other values.
J	Screen	Displays all results.
K	Output on/off buttons	Switch output on/off.
L	Negative output terminal	Negative high current output terminal.
M	Current clamp connector	Input sockets for optional current clamp for testing with both sides of test object earthed.
N	mV input	Input sockets for mV sense lead. Screen terminal may be used to connect cable screen for long leads.
O	Positive output terminal	Positive high current output terminal.

### 1.1.2 Display

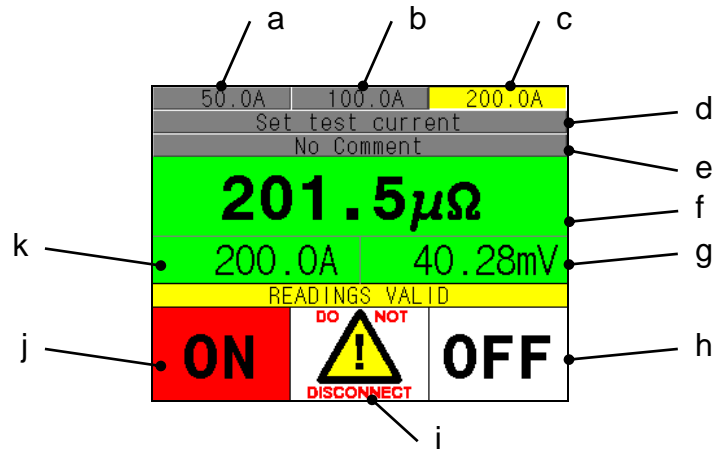

Figure 1.2 Display

a	Current preset 1	Stored test current 1
b	Current preset 2	Stored test current 2
c	Current preset 3	Stored test current 3
d	Set test current display	Turn the adjust knob to set a different test current. The target current is shown on this line. The current can be selected with the output on or off.
e	User comment line	This line displays the current comment that will be stored to the memory key with the next result. To change the comment, press the comment/menu button briefly when the output is switched off. Edit the comment using the USB keyboard.
f	Resistance reading	Calculated resistance reading from A & mV. The background of the reading is yellow when the current is being set by the unit, and turns green when the resistance value is valid.
g	mV sense value	Voltage measured by the mV sense terminals.
h	Output off indicator	Green background – output is off. Press the button below to switch the output off.
i	Do not disconnect indicator	The unit shows “do not disconnect” and a yellow warning triangle when there is current flowing in the output circuit. Do not break the output circuit when this indicator is showing.
j	Output on indicator	Red background – output is on. Press the button below this label to switch the output on.
k	Output current	Actual output current to load. This displays the measured current being delivered to the load.

If the current clamp is in use, this may be less than the test current – see section 2.7 for details.

### 1.1.3 Warning messages

High resistance trip	<p>The resistance in the high current circuit is higher than the maximum for the set test current. Maximum resistances for different test currents are shown below (these include the resistance of the high current leads):</p> <table> <thead> <tr> <th>Test current</th> <th>Maximum resistance</th> </tr> </thead> <tbody> <tr> <td>1A</td> <td>5Ω</td> </tr> <tr> <td>5A</td> <td>1Ω</td> </tr> <tr> <td>10A</td> <td>500mΩ</td> </tr> <tr> <td>20A</td> <td>250mΩ</td> </tr> <tr> <td>50A</td> <td>100mΩ</td> </tr> <tr> <td>100A</td> <td>50mΩ</td> </tr> <tr> <td>150A</td> <td>33mΩ</td> </tr> <tr> <td>200A</td> <td>25mΩ</td> </tr> </tbody> </table>	Test current	Maximum resistance	1A	5Ω	5A	1Ω	10A	500mΩ	20A	250mΩ	50A	100mΩ	100A	50mΩ	150A	33mΩ	200A	25mΩ
Test current	Maximum resistance																		
1A	5Ω																		
5A	1Ω																		
10A	500mΩ																		
20A	250mΩ																		
50A	100mΩ																		
100A	50mΩ																		
150A	33mΩ																		
200A	25mΩ																		
Current trip	The load current is higher than 200A. If this message appears, re-try the test. If the message re-appears, select a lower test current.																		
Low resistance trip	The resistance between the high current terminals is too low, and the unit cannot set the current. This will only occur if the output leads have a resistance less than a pair of 1m 35mm <sup>2</sup> leads.																		
Temperature trip	The unit will trip on over temperature if the internal temperature exceeds 75°C. The over-temperature trip will reset when the internal temperature drops to 55 °C. The fans will continue to run while the unit cools.																		
Reversed mV trip	If the mV input is connected with the wrong polarity the unit will trip. Reverse the sense leads and re-start the test.																		
Reversed probe input	The output will trip if the optional current probe is connected in reverse (or the current is flowing in the wrong direction through the clamp).																		
Probe current trip	The unit will trip if excessive current is detected in the probe circuit.																		

## 1.2 Outputs and inputs

### 1.2.1 Main output

Maximum output voltage:	5.0Vdc
Full load output voltage	5.0Vdc
Output current:	100A continuous
	200A 15 min on/15 min off
Output ripple:	<2.5%

The current displayed on the unit in operating mode has a resolution of 0.1A. The current metered internally to calculate the resistance is measured to a much higher resolution.

Range	Resolution	Accuracy
1.0-200.0A	0.1A	$\pm 0.5\%$ of reading $\pm 1$ digit

### 1.2.2 Sense voltage input

Maximum measurement voltage: 5V dc

The sense voltage metering is auto-ranging with the following ranges:

Range	Resolution	Accuracy
0 – 9.999mV	0.001mV	$\pm 0.5\%$ of reading $\pm 5$ digits
10.00 – 99.99mV	0.01mV	$\pm 0.5\%$ of reading $\pm 5$ digits
100.0 – 999.9mV	0.1mV	$\pm 0.5\%$ of reading $\pm 5$ digits
1.000 – 5.000V	0.001V	$\pm 0.5\%$ of reading $\pm 5$ digits

### 1.2.3 Resistance ranges

The DMO200 selects a suitable resistance range based on the output current and the sense voltage measured.

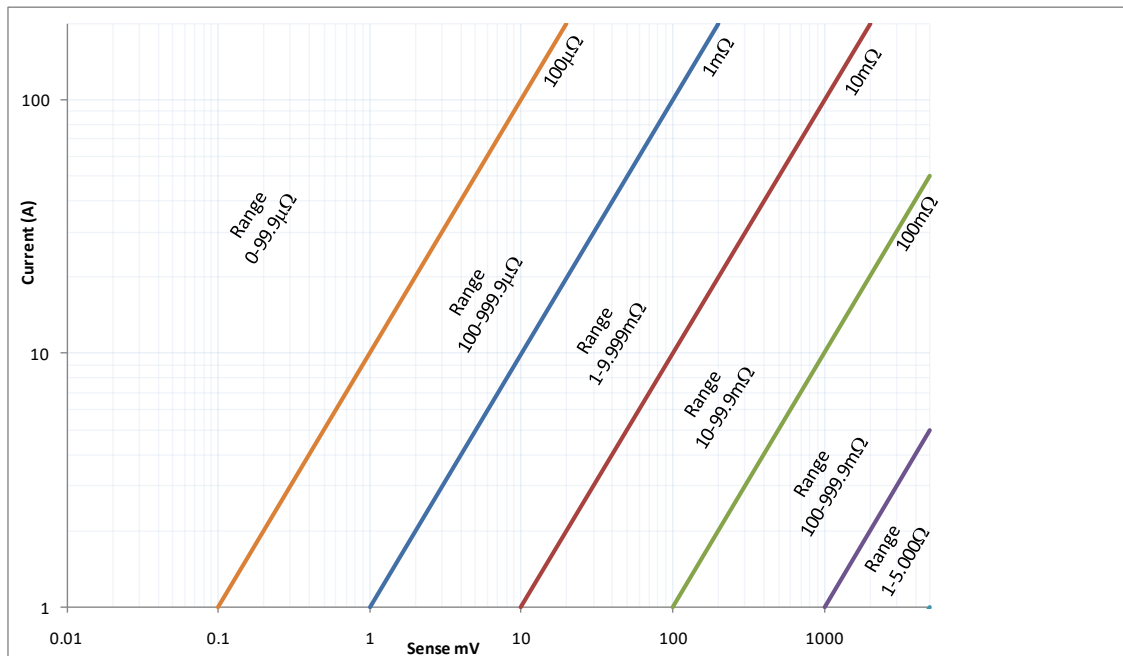

Figure 1.3 Resistance ranges

## 1.3 Installation

### 1.3.1 Environment

The DMO200 is designed for use in indoor industrial and electrical substation environments.

Maximum altitude:	2000m
Temperature:	0°C to 45°C operating -20°C to 60°C storage
Relative humidity:	90% non-condensing
Protection rating:	IP54 lid closed IP30 in use

### 1.3.2 Supply requirements

90-264Vac single phase 1300VA maximum

The supply must have an earth connection. When used in a substation environment the unit must be earthed through the mains supply and also using the front panel earth terminal. Use the supplied green/yellow earth lead to make this connection.

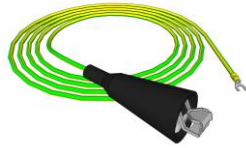

Figure 1.4 Earth lead

### 1.3.3 Connection cable ratings

The cables supplied with the unit have the following ratings:

Lead	EN61010 category	Current rating	Voltage rating
35mm <sup>2</sup> current output cables	CAT I	200A	24Vdc
Sense leads	CAT I	5A	24Vdc

### 1.3.4 Overload protection

Location	Protection
Mains supply	T10A fuse
Output	Current trip Thermal trip



## 2. OPERATION

### 2.1 Principle of operation

The DMO200 uses a four wire Kelvin connection to measure low resistances without the resistance of the leads affecting the result. The test current is supplied to the test object by one set of leads, and the resulting voltage across the sample is measured by a second set of leads. The resistance is then calculated from the current and the sense voltage.

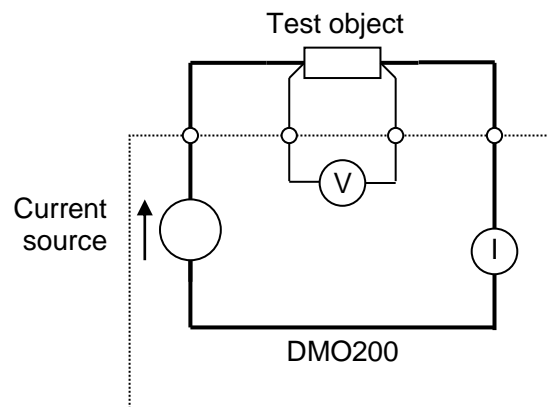

*Figure 2.1 Kelvin resistance measurement*

The positioning of the high current injection leads is therefore not critical provided the full current flows through the test sample. The exact connection point of the sense leads can affect the reading, and these connection points should be chosen carefully to only include the resistance to be measured.

## 2.2 Connections

Always ensure that power to the test object is switched OFF, and that the object under test is isolated from the supply before making any connections. One side of the object should always be grounded for safety. The DMO200 is also capable of accurate resistance measurements with both sides of the object grounded when the optional current clamp is used (see section 2.7).

It is important to ensure that the high current leads are securely connected to the test object, and that they cannot slip off during testing. The leads should NEVER be disconnected whilst the output is on and current is flowing.

The exact point of connection of the high current leads to the test object is not usually critical, as long as the full test current flows through the resistance to be measured. The positioning of the sense connections on the test object is very important, and connecting these in the wrong place will result in errors in the resistance readings.

The sense voltage connections should always be positioned within the current injection path as shown below. Erroneous readings will result if the sense leads are connected outside of the current injection path.

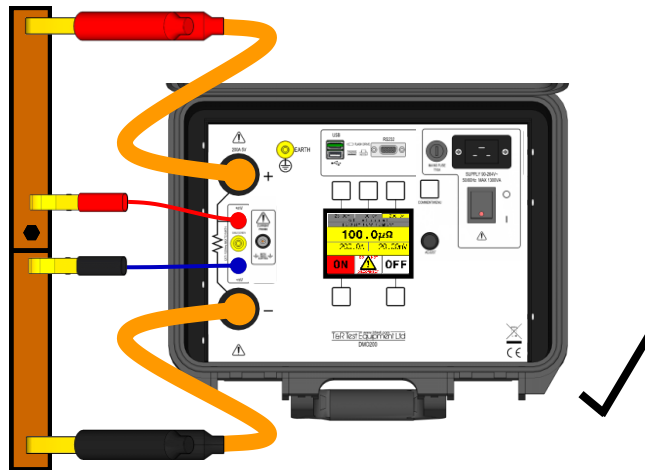

Figure 2.2 Correct sense lead connection inside current path

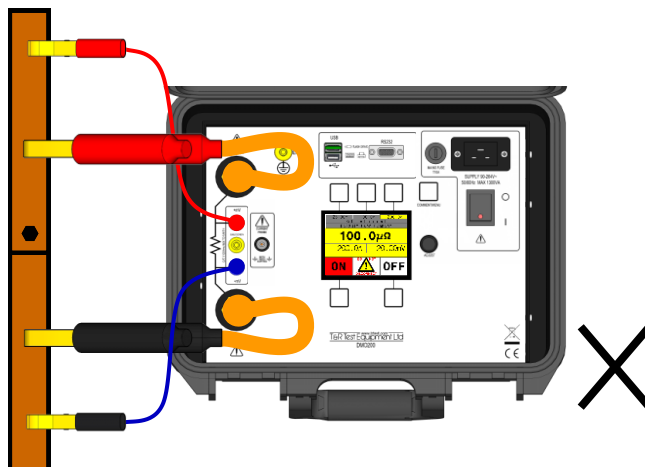

Figure 2.3 Incorrect sense lead connection outside current path



## 2.3 Method of operation

### 2.3.1 Connection of leads

Ensure that the test object is disconnected and isolated from any supply, and earth one side of the test object.

Connect the green/yellow earth lead supplied with the unit to the earth terminal on the front panel and connect to a low impedance local earth (substation earth or tower frame)

Connect the unit to a suitably rated mains supply with the supply lead provided.

Connect the high current leads to the output terminals and to the test object.

Connect the sense lead to the unit and to the test object.

### 2.3.2 Switching on

When power to the unit is switched on, the DMO displays a start-up message identifying the unit and software version. The unit will then show the standard operating screen with the off indicator highlighted.

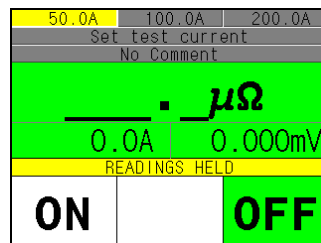

Figure 2.4 Screen at startup

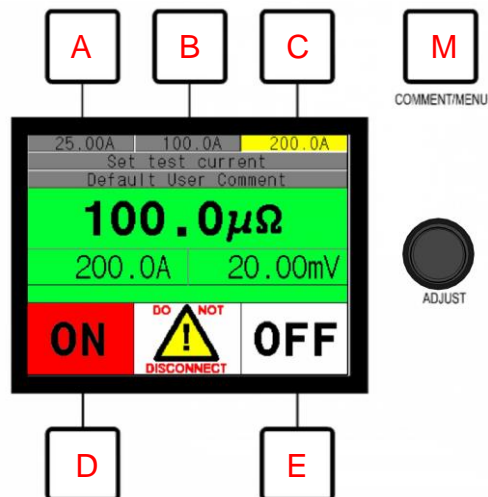

Figure 2.5 Main screen and buttons

### 2.3.3 Taking a measurement

Select the required test current by pressing button A, B or C. By default, these will be set to test currents of 50A, 100A and 200A. If you require a different test current, use the adjust knob to set the required current.

Press the on button to switch the output on (button D above). The unit will set the output current to the preset test current. When the current has stabilised, the unit will calculate the resistance of the test object. The background of the measurements changes from yellow to green to indicate that the resistance shown is valid.

When a valid reading has been obtained, switch the output off using button E. The reading from the test will be held on the display.

The current can be changed with the output of the unit on or off – either select a different preset current or use the adjust knob.

The current reading will be written to the USB memory key (if present) when the output is switched off.

### 2.3.4 **Setting a custom test current**

The adjust knob is used to set a custom test current (a test current not shown as one of the presets). When the knob is turned, the second line on the display shows “SET TEST CURRENT [100.0]” where 100.0 is the current that you are setting. If the output of the unit is switched off when you change the value, this current will be used as the test current when the output is switched on. If the output is switched on when the change is made, the output current will track this value.

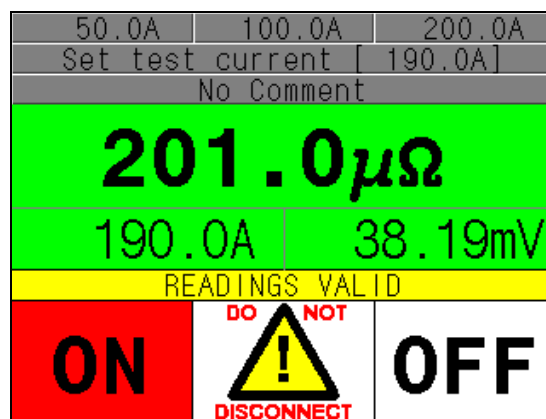

Figure 2.5 Setting a custom test current

### 2.3.5 **Storing a custom current as a preset**

When a custom current has been set this can be stored as one of the preset values. Press and hold one of the top three buttons for two seconds to store the current as a preset.

### 2.3.6 **Reversed sense leads**

The sense leads must be connected with the correct polarisation relative to the main current leads (the +ve sense lead must be connected to a more positive point than the –ve sense lead). If the sense leads are reversed, the unit will switch the output off and display the message “Reversed mV input”. If this occurs, the sense leads should be reversed.

## 2.4 Data storage

The DMO200 stores the displayed results to the USB memory key every time the output is switched off. A comment can be entered using the supplied keyboard to store with each result. The results are stored to a CSV (Comma Separated Value) file that can be opened by any spreadsheet program.

The unit type (DMO200), software version and unit serial number are stored in a header line in the file.

The following data is stored in the file for each reading:

- Date
- Time
- Output current
- Sense voltage
- Resistance reading
- Reading valid confirmation (Y/N)
- Comment

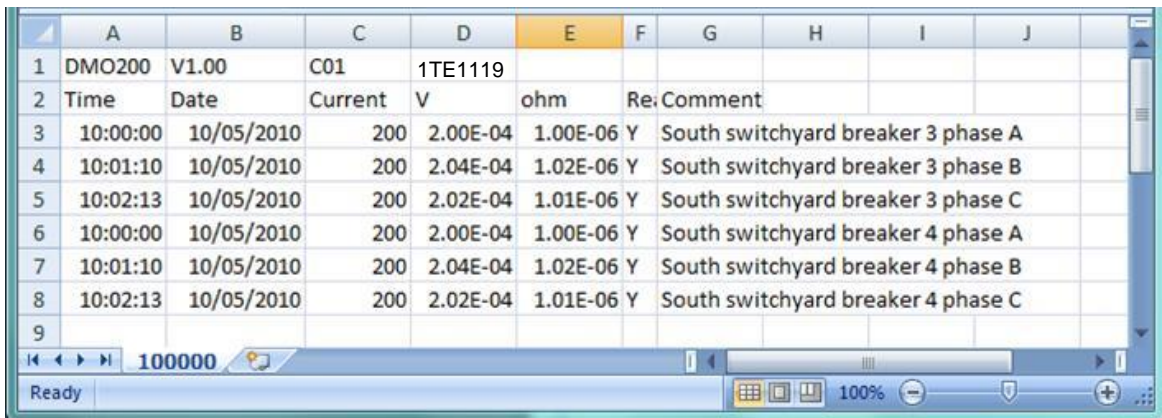

	A	B	C	D	E	F	G	H	I	J
1	DMO200	V1.00	C01	1TE1119						
2	Time	Date	Current	V	ohm	Re:	Comment			
3	10:00:00	10/05/2010	200	2.00E-04	1.00E-06	Y	South switchyard breaker 3 phase A			
4	10:01:10	10/05/2010	200	2.04E-04	1.02E-06	Y	South switchyard breaker 3 phase B			
5	10:02:13	10/05/2010	200	2.02E-04	1.01E-06	Y	South switchyard breaker 3 phase C			
6	10:00:00	10/05/2010	200	2.00E-04	1.00E-06	Y	South switchyard breaker 4 phase A			
7	10:01:10	10/05/2010	200	2.04E-04	1.02E-06	Y	South switchyard breaker 4 phase B			
8	10:02:13	10/05/2010	200	2.02E-04	1.01E-06	Y	South switchyard breaker 4 phase C			
9										

Figure 2.6 Results file opened in spreadsheet

### 2.4.1 Entering a comment

To enter a comment to be stored with results the keyboard must be connected to the lower USB socket. Comments can only be edited with the output off (with the output on the COMMENT/MENU button stores an extra result).

With the output switched off, press the COMMENT/MENU button. When editing is completed, press enter on the keyboard or press the OK button on the DMO200.

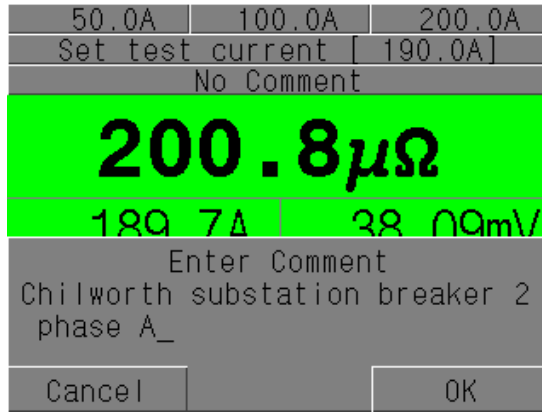

Figure 2.7 Editing the comment

The comment is stored with the result each time the output is switched off. A USB write icon briefly flashes up to the right of the  $\mu\Omega$  reading when data is written to the USB memory key.

### 2.4.2 Storing additional readings

The reading is stored automatically every time the output is switched off. If extra readings are required while the output is on, press the COMMENT MENU button each time a reading is to be stored. The extra readings are written to the USB key when the output is next switched off.

### 2.4.3 USB memory key folders and files

All files from the DMO200 are stored on the memory key in the folder TRTEST in a subfolder named by date (e.g. 23-06-10). The data file is created with a name composed of the time at which the first test was carried out (e.g. 153106.csv). A new file is created when the first result is written to the memory key after the unit is switched on (switching the unit off and on or removing and re-inserting the memory key will force the unit to create a new results file).

## 2.5 Result printer

An optional thermal printer may be connected to the RS232 port. The current result is written to the printer each time the output is switched off. The printer kit is available from T&R Test equipment, part number 210. Software version 1.01 or later is required to use the serial printer. An example printout is shown to the right.

```
DMO200
(C) T&R Test Equipment Limited 2010
Unit serial no. 01TE1126
SW Version 1.01      GW Version 1.06
.....
03/11/10 12:15:01 50.03A 21.32mV 426.2μΩ
.....
03/11/10 12:15:14 50.04A 21.41mV 427.9μΩ
.....
03/11/10 12:15:24 50.13A 21.46mV 428.1μΩ
.....
```

## 2.6 DMO200 limit functions

The DMO200 may be programmed with a pre-set test current, upper and lower pass limits for resistance and length of test for production line applications. Up to three different tests may be programmed which are assigned to the three programmable buttons above the display. When limit mode is enabled the buttons select limit tests rather than preset currents.

When a limit mode test is selected the following occurs the output is switched on:

- The current is set to the pre-programmed value.
- The current is held for the pre-programmed time.
- At the end of the test time the resistance is compared against the limits and the output switches off.
- The screen shows a pass/fail indication (green for pass, red for fail).

### 2.6.1 Setting Limits

Press and hold the comment/menu button for two seconds to enter the menu system and then select "Limit Mode Setup" from the menu.

The limit mode setup screen will be shown for test 1 with the "enabled" menu option highlighted. To enable this test, use the ADJUST control to set this value to Yes.

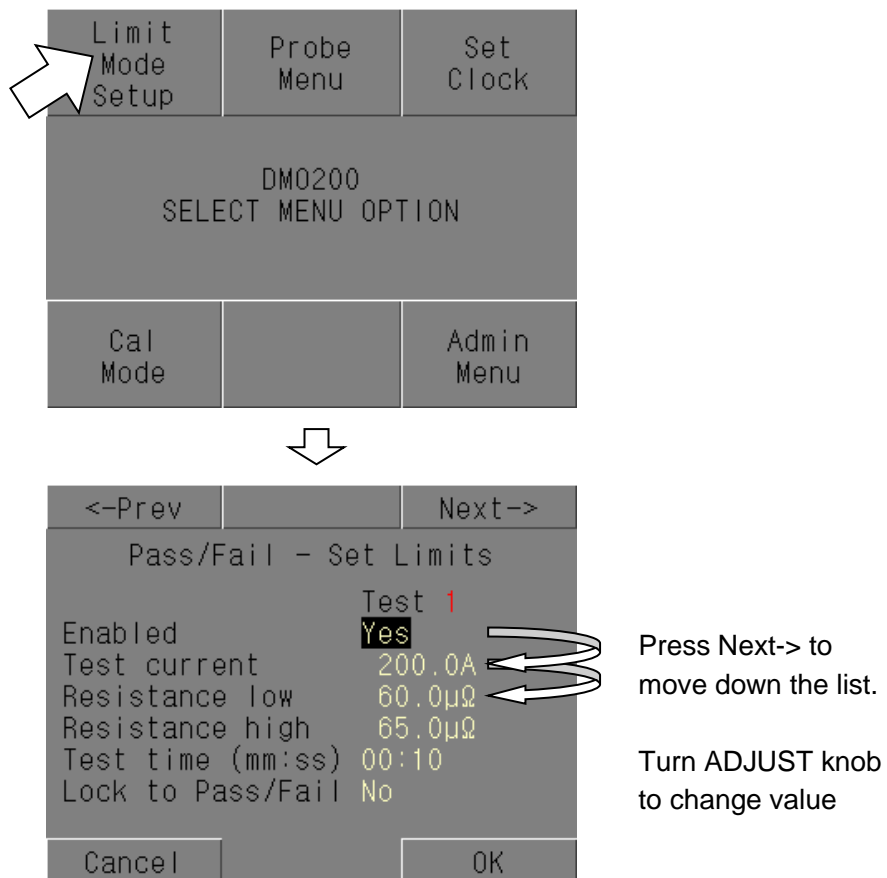

Figure 2.8 Limit mode setup

Press the Next-> button (top right) to move to the next option (Test current). Set the test current to the desired value using the ADJUST control.

Press Next-> and set the upper and lower limit values for the resistance and then the test time. The output is held on for the selected test time after the current has stabilised before the reading is finalised and a pass/fail indication is given.

Lock to Pass/Fail has no function in the current version of the software. To set up additional limit tests, press Next-> again when "Lock to pass/fail" is selected to move to the setup for test 2. Buttons are only shown on the opening screen for limit tests that are enabled. To disable limit mode, disable all three limit mode tests.

Press OK to accept the limit settings. The unit will give a prompt of "Save Changes?" – press OK to continue and save the changes.

Press COMMENT/MENU to return to the main operating screen. The standard operating screen will now be replaced with the limit mode operating screen.

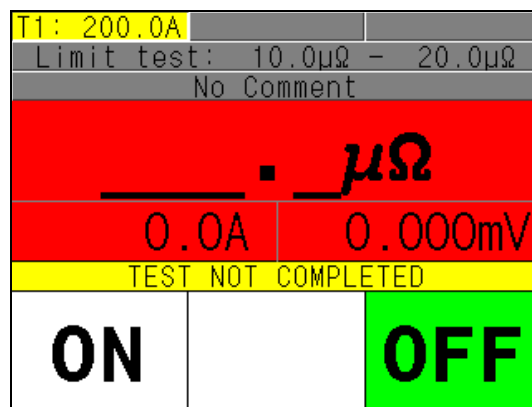

Figure 2.9 Limit mode operating screen

### 2.6.2 Operation

Press the ON button to start the test. When the current has been set and the pre-set time has elapsed a pass/fail indication will be shown.

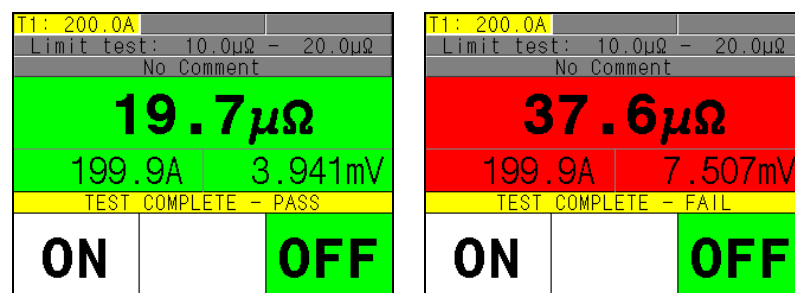

Figure 2.10 Limit mode pass and fail screens

## 2.7 Current clamp for operation with both sides grounded

The DMO200 may be used with an optional DC current clamp to accurately measure resistances where there is an alternative current path in parallel with the main current path (e.g. testing circuit breaker contact resistances with both sides of the circuit breaker earthed). A suitable current clamp is available from T&R Test Equipment, part number A224-0001. This is a 100/1000A dc probe with an output of 10mV/A for 100V and 1mV/A for 1000A.

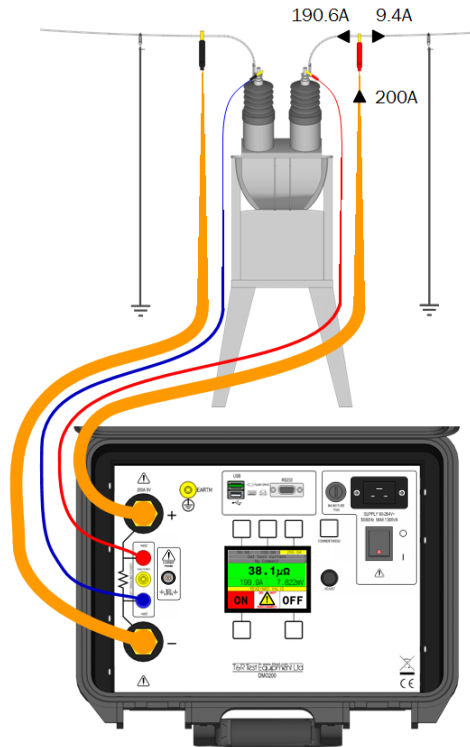

Figure 2.11 Inaccuracy with alternative current path

In the above example a circuit breaker is under test with a contact resistance of  $40.0\mu\Omega$ . 190.6A flows through the breaker and 9.4A flows through the earth path. The sense voltage across the circuit breaker is 7.622mV, and the calculated current is therefore  $38.1\mu\Omega$  instead of the correct  $40.0\mu\Omega$  – an error of 4.75%.

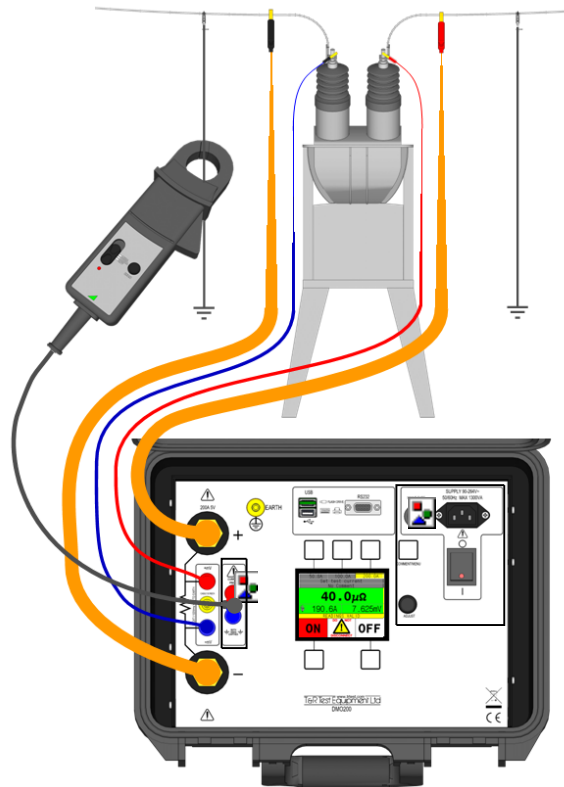

Figure 2.12 Correction of inaccuracy with current clamp

With the current clamp installed and enabled, the DMO200 measures the current in the earth loop (9.4A) using the current clamp, and now calculates the test current as  $200-9.4A=190.6A$ , giving a resistance of  $7.625mV/190.6A=40.0\mu\Omega$ .

### 2.7.1 Probe details (T&R Test A224-0001 probe)

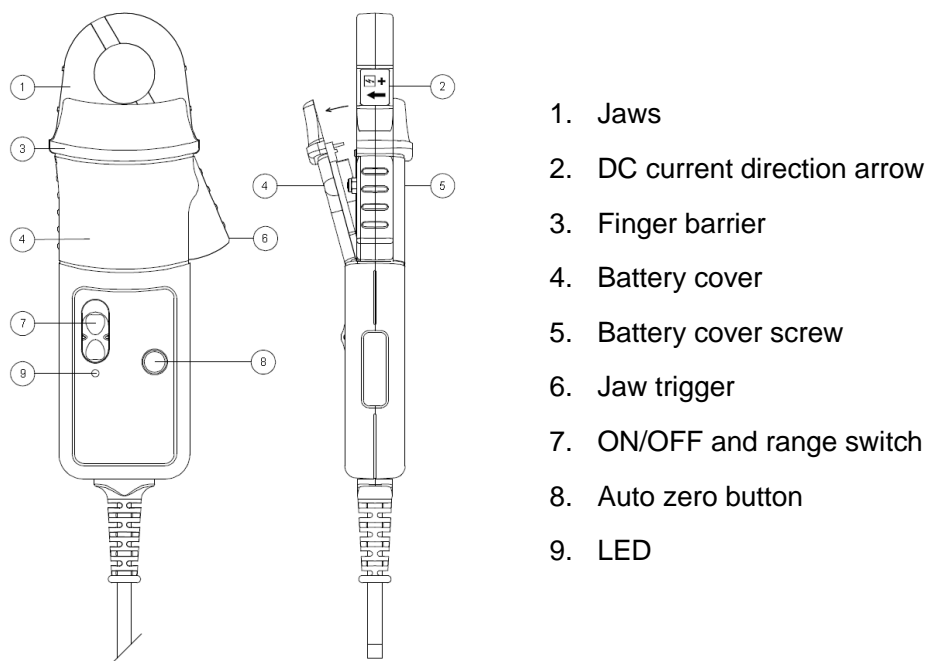

Figure 2.13 A224-0001 current clamp

The probe should be set to the 100A range for use with the DMO200.



To use the probe, select the range required and press the zero button (whilst keeping the probe away from any current-carrying cables). The LED will show green when the probe is switched on. If the battery is low the LED will flash green. Refer to the manual supplied with the probe for details on changing the battery.

The probe will automatically switch off after 10 minutes. To stop the probe switching off automatically, hold down the zero button whilst switching on the probe. The LED will show red to indicate that the auto power-off feature has been disabled.

Always ensure that the jaws are properly closed around the current-carrying conductor. The maximum conductor size is 32mm.

### 2.7.1 Probe connection and setup

The probe must be enabled via the probe menu to operate and correct the reading. Before operation for the first time, the probe must be calibrated by the DMO200.

Connect the probe to the current probe socket on the front of the unit. The ground side of the probe must connect to the blue terminal.

Connect the high current output leads to the unit, and connect the large clips together to make a loop. Ensure that the connection is secure – the unit will pass 60A (for a 10mV/A probe) or 100A (for a 1mV/A probe) through the loop.

Hold down the zero button on the probe and switch the probe to the 100A range (holding the zero button down whilst switching on the probe disables the auto power-off feature of the probe). Release the ZERO button and then press it again briefly to zero the offset of the probe. Clip the probe on the loop, ensuring that the current passes through the clamp window in the direction marked on the clamp.

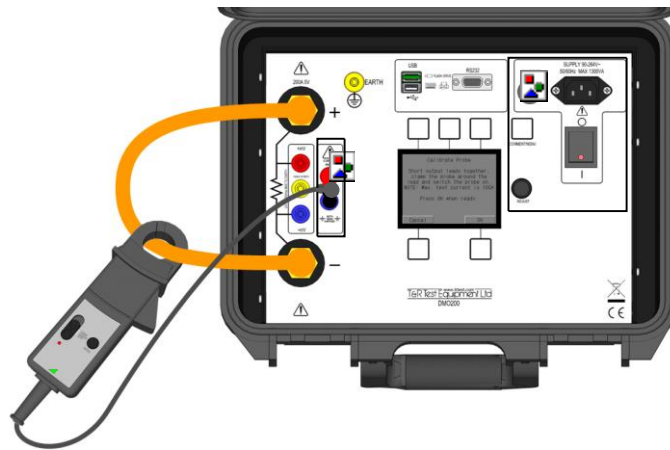

Figure 2.14 Connections for probe setup

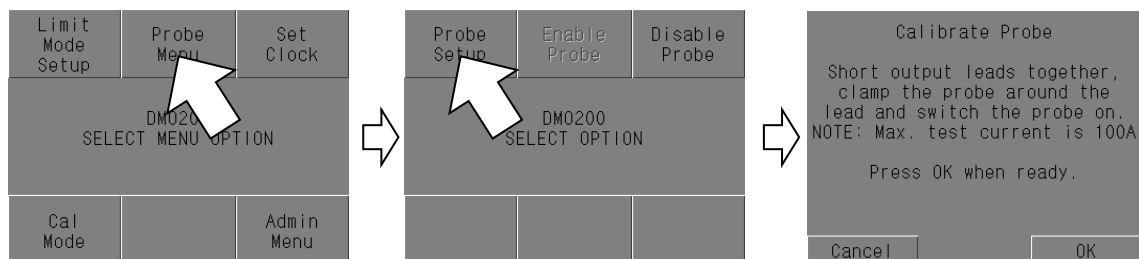

Figure 2.15 menus for probe setup

Enter the menu by holding the COMMENT/MENU key down for two seconds. Select the Probe Menu and then press “Probe Setup”. Check that the connections are correct and secure, and then press OK.

The unit will switch on and cycle the current a number of times between zero and 100A to calibrate the probe to the unit. When the readings are consistent, the unit switches the output off and displays “Setup complete”. If the unit stops and displays “Reversed probe”, re-check the polarity of the output of the probe and the direction of the current through the probe. Also check that the probe has not switched off – the probe power automatically switches off after 10 minutes unless the ZERO button is held down whilst switching the probe on.

The probe setup needs to be repeated if a different probe is used with the unit or if the range is changed on the probe. It should also be repeated at intervals not exceeding one year.



Ensure that the probe is switched to the range on which it was set up. If the probe was set up on the 100A range, it can ONLY be used on the 100A range unless it is set up again on the 1000A range (and vice versa).

### 2.7.2 Enabling the probe

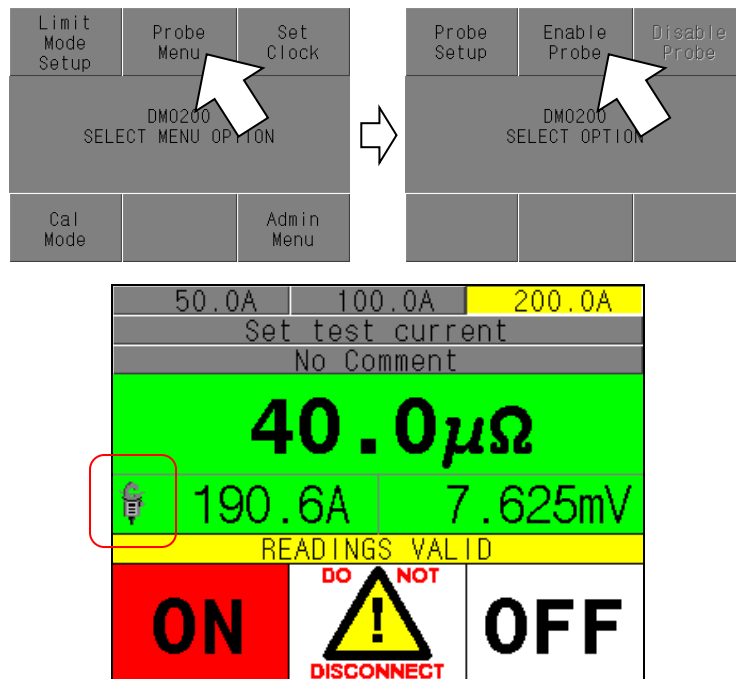

Figure 2.16 Enabling the probe

To enable the probe, press and hold the menu key for two seconds, select the Probe Menu and then select “Enable probe”. Press COMMENT/MENU twice to exit the menu. The unit will now display a small probe symbol next to the output current to show that the probe is enabled.

When taking measurements without the probe, ensure that the probe is disabled to ensure that accurate results are obtained. The probe will also be disabled when the unit is switched off and on again.

### 2.7.3 Operation

Clip the probe around the conductor forming the alternative current path (one of the earth leads in the case of a circuit breaker with both sides grounded). Ensure that the current flows through the clamp is in the direction of the arrow marked on the clamp.

Make sure that the probe is enabled (probe symbol to left of current on display) and switched on. Set the required test current and switch on the output of the DMO200. The current displayed will be less than the pre-set test current because the current is split between the current through the resistance to be measured and the alternative current path being monitored by the current probe. The current shown is the output current less the current measured by the current probe (this is the current used to calculate the resistance). If it is necessary to set the test current through the resistance to be measured to a specific test value this can be achieved by increasing the current manually using the ADJUST knob.

For example, if a test current of 100A is set to test a circuit breaker where 10A flows through the earth connections, the actual current through the breaker is 90A (which is shown on the display). Manually increase the test current to 110A using the ADJUST knob to bring the current displayed up to 100A. The combined current of the current through the test object and alternative current path cannot exceed 200A.

Note: If the unit stops and gives a “reversed probe input message” whilst setting the current, check the current polarity and check that the probe is switched on.

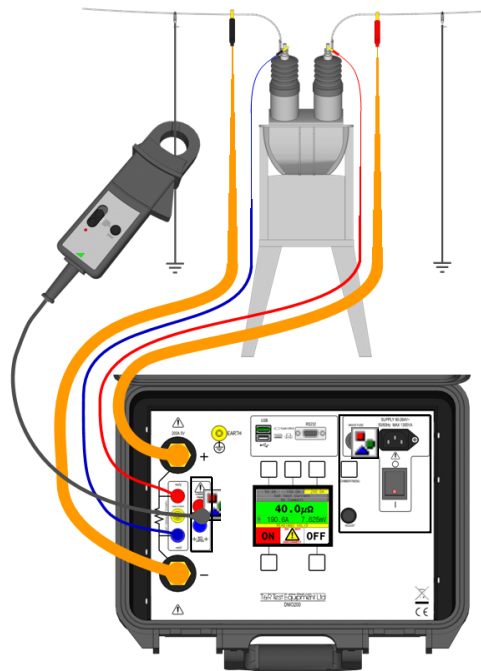

Figure 2.17 Connection of current clamp

### 3. MAINTENANCE

There are no user-maintainable parts in the DMO200. Contact your nearest T&R Test Equipment distributor for servicing.



WARNING

Hazardous voltages are present inside the DMO200. The unit must only be opened and serviced by suitably competent repair facilities.

Before removing the unit from its case, ensure that the mains supply lead is disconnected from the unit.

## **4. ACCESSORIES**

### **4.1 Standard accessories supplied with the DMO200**

T10A HRC 32mm spare fuse

IEC mains input lead.

Operating & Maintenance Manual.

2 x 3m 35mm<sup>2</sup> output leads terminated in large clips (standard, Kelvin, or Nevada)

1 x 3m sense lead terminated in small clips

(not supplied if unit is supplied with Kelvin lead set)

1 x 5m earth lead terminated in croc clip

USB keyboard

USB memory key

Lead case

## 4.2 Optional accessories

	Part no.	Description
	A224-0001	200A current clamp for DMO200 for testing circuit breakers with both sides earthed
	A224-0003	DMO200 3m Kelvin clamp lead set
	A224-0024	DMO200 5m Kelvin lead set with large G clamps (with adaptors for overhead line use)
	A224-0004 A224-0005 A224-0006	DMO200 3m output & sense extension lead set DMO200 5m output & sense extension lead set DMO200 10m output & sense extension lead set
	A224-0002	DMO200 replacement standard 3m lead set
	A000-0005	DMO200 replacement earth lead
	A219-0002	Replacement USB micro keyboard
	A219-0003	Replacement 2Gb USB micro memory key
	210	Printer kit with 112mm thermal paper

## 5. OVERALL PERFORMANCE SPECIFICATION

### 5.1. Insulation resistance at 1000V DC

The insulation resistance will not be less than 10M $\Omega$  between mains input to frame and all isolated outputs.

### 5.2. Applied voltage test

Mains input to frame      2.5kVdc for 5 seconds.

Output to frame            500Vdc for 5 seconds.

### 5.3. Accuracy of instrumentation and associated circuit components

mV ranges                     $\pm 0.5\%$  rdg  $\pm 5$  digits

Current ranges                 $\pm 0.5\%$  rdg  $\pm 1$  digit

#### Resistance accuracy

Current	Resistance	Accuracy
50-200A	$\leq 100\mu\Omega$ $> 100\mu\Omega$	$\pm 0.5\%$ rdg $\pm 2$ digits $\pm 1\%$ rdg $\pm 2$ digits
10-49A	Full range	$\pm 1\%$ rdg $\pm 10$ digits
5-9.9A	Full range	$\pm 1\%$ rdg $\pm 20$ digits
1-4.9A	$\geq 1m\Omega$	$\pm 1.5\%$ rdg $\pm 20$ digits





## 6. REVISION

Product/Type: DMO200 200Adc Digital Micro-Ohmmeter  
File: OM0013.docx  
Author: I.D.W. Lake

Issue/Date: 5  
Date: 24/02/17  
Modified by: K. Mupotsa

Checked By: G Biggs	Date: 30/05/17
---------------------	----------------

Drawings Required

DMO200: 001715 latest issue