

T&R Test Equipment Ltd

TRUSTED & RELIABLE

OPERATING AND MAINTENANCE MANUAL

Product: ***High Voltage AC Test Set***

Type: ***KV30-100 mk2***

KV50-100 mk2

KV50-200 mk2

KV50-250 mk2

KV100-100 mk2



DESIGNED AND MANUFACTURED IN THE UK BY:

T & R Test Equipment Limited

15-16 Woodbridge Meadows, Guildford, Surrey, GU1 1BJ, United Kingdom

Telephone: 01483 207428

e-mail:

sales@trtest.com

Fax.: 01483 511229

Web:

www.trtest.com

GENERAL SAFETY STATEMENT

The following safety precautions should be reviewed to avoid injury to the user and damage to the product (and other products connected to it). To avoid potential hazards only use this product as specified.

- **Only suitably qualified personnel should use this equipment. Servicing of this product should only be carried out by suitably qualified service personnel.**
- **The high voltage generated by this unit is extremely dangerous and may be fatal.**
- **This unit is designed only for operation in a designated high voltage test area with suitable interlocks and safety procedures..**

To Avoid Fire Hazards and Personal Injury

- Use the correct power supply lead. Only use a suitably rated and approved power supply lead for the country of use.
- Ensure that systems that the unit is to be connected to are dead.
- Do not connect and disconnect leads whilst outputs are switched on.
- Ensure that the product is grounded. To avoid electric shock it is essential that the grounding conductor is connected to the earth ground. Additional earth terminals are provided on the control unit and HV transformer that must be connected to a local earth. Ensure that the unit is properly grounded before making any connections to inputs or outputs.
- Output ratings must be observed to prevent fire hazards and risk of injury to the operator. Consult the product manual for ratings information before making any connections.
- It is ESSENTIAL to consult the product manual for rating information before making any connection to a terminal or terminal group marked with a warning triangle.
- Only use fuses of a type and rating specified for this product.
- Do not operate the unit out of its case or with any covers or panels removed.
- Do not touch exposed connections and components when power is present.
- Do not operate the product if any damage is suspected. Refer the unit to qualified service personnel to be checked.
- Do not operate the unit in wet or damp conditions
- Do not operate the unit in an explosive atmosphere
- Some test objects may generate X-rays when tested (particularly those containing a vacuum). Ensure adequate safe distances to the test object are maintained or suitable screening is used.
- This unit is not designed for unattended operation

If any further queries occur regarding the usage and maintenance of the equipment detailed in this manual, please refer these to the supplier of the equipment in the first case or to:

T & R Test Equipment Limited

HIGH VOLTAGE SAFETY

It is essential to follow safe working procedures when working with high voltage. Information on accepted codes of practice should be obtained from your local health and safety regulatory body.

It is essential that the KV100-100 mk2 series test sets are only used in a suitable test environment. EN50191:2001 (Erection and Operation of Electrical Test Equipment) provides information on the installation and use of test installations and is referenced by health and safety law in the EU. EN50191:2001 is available from T&R Test Equipment.

IEEE standard 510-1983 (IEEE Recommended Practices for Safety in High-Voltage and High-Power Testing) also provides a working framework for establishing safe procedures, but must be read in conjunction with local regulations and accepted codes of practice.

The following excerpts are taken from IEEE 510

- All ungrounded terminals of the test equipment or apparatus under test should be considered as energised.
- Common ground connections should be solidly connected to both the test set and the test specimen. As a minimum, the current capacity of the ground leads should exceed that necessary to carry the maximum possible ground current. The effect of ground potential rise due to the resistance and reactance of the earth connection should be considered.
- Precautions should be taken to prevent accidental contact of live terminals by personnel, either by shielding the live terminals or by providing barriers around the area.
- The circuit should include instrumentation for indicating the test voltages.
- Appropriate switching and, where appropriate, an observer should be provided for the immediate de-energisation of test circuits for safety purposes. In the case of dc tests, provisions for discharging and grounding charged terminals and supporting insulation should also be included.
- In the use of signal-gathering equipment, each device should be used in such a manner that it will not present a personnel hazard should it inadvertently become a part of the high-voltage circuit, or fail to function properly.
- High-voltage and high-power tests should be performed and supervised by qualified personnel.
- Consideration should be given to safety regulations which may apply to specific circumstances; for example, HSE, company, or government regulations.

SAFETY TERMS AND SYMBOLS

The following safety symbols appear on the equipment:



CAUTION/WARNING – Refer to manual



DANGER – High voltage



Mains off



Mains on

The following safety symbols appear in this manual:



CAUTION

This action or procedure may be dangerous if not carried out correctly, and may cause damage to the equipment or connected equipment.



WARNING

This action or procedure may cause injury or death to the operator or other personnel if not carried out correctly using applicable safety procedures.

CONTENTS

1.	DESCRIPTION OF EQUIPMENT	7
1.1	Electrical Specification	7
1.1.1	Input and Output	7
1.2	Front Panel Controls	8
1.2.1	Standard Units Without Timer	8
1.2.2	-T units With Test Timer	9
1.3	Rear Panel Connections	10
1.3.1	Alarm Sounder	10
1.3.2	Signal Beacons	10
1.3.3	Earthing Mechanism Control Output	11
1.4	Output Voltage Control	11
1.5	Overload Protection	12
1.5.1	Fixed Overload	12
1.5.2	Variable Overload	12
1.6	Metering	13
1.6.1	Metering Ranges	13
1.6.2	IMPORTANT NOTE - Metering Connections	13
1.7	Test timer (-T suffix units only)	14
1.7.1	Setting the Test Time	14
1.7.2	Starting the Timer	14
1.7.3	Resetting the Timer	14
1.7.4	Cancelling the Alarm	14
1.7.5	Disabling the Timer	14
1.8	Interlock Circuits	15
1.8.1	Zero Voltage Interlock	15
1.8.2	External Interlock/Emergency Stop Circuit	15
1.9	Output Configuration	16
1.9.1	HT Transformer Terminals	16
1.10	Construction	17
1.10.1	Control Unit	17

1.10.2	HV Transformer	17
2.	OPERATION	18
2.1	Safety	18
2.1.1	Installation	18
2.1.2	Operation	18
2.2	Connections	21
2.3	Method of Operation	23
3.	MAINTENANCE	24
3.1	Output Control Variable transformers	24
3.2	HV Output Transformer	24
4.	ACCESSORIES	25
4.1	Standard Accessories	25
4.2	Optional Accessories	25
5.	OVERALL PERFORMANCE SPECIFICATION	26
5.1	Insulation resistance at 1000V DC	26
5.2	Applied voltage test	26
5.3.	Accuracy of instruments	26
5.4.	H V Transformer	26
5.5.	Complete Equipment	26
6.	REVISION	27

1. DESCRIPTION OF EQUIPMENT

The KV series of high voltage test systems consist of a separate control unit and high voltage transformer.

Units with test timer option (-T suffix on unit name) have a test timer fitted that sounds an alarm at the end of the preset test period.

The mk2 versions of the KV series have safety systems incorporating the following features:

- Emergency stop button on control unit
- Dual output contactors controlled by safety monitoring relay
- Audible alarm on detection of contactor fault
- Safety monitored external dual channel emergency stop/interlock circuit
- Output for external signal beacons
- Output for control of automatic earthing mechanism

All references to the “KV series” in this manual refer to the KV30-100 mk2, KV50-100 mk2, KV50-200 mk2 and KV100-100 mk2 unless a specific reference is made to a particular unit.

NOTE – To operate this equipment it will first be necessary to connect to an external interlock circuit using the 6 pin plug provided. See section 1.7.2 for further information.

1.1 Electrical Specification

1.1.1 Input and Output

Supply requirements 230V±10% 50/60 Hz

Unit	Supply voltage	Supply maximum VA	Output voltage	Output current	
				Continuous	5 min on/ 15 min off
KV30-100	230V ±10%	3.5kVA	0-30kV	50mA	100mA
KV50-100	230V ±10%	6kVA	0-50kV	50mA	100mA
KV50-200	230V ±10%	11kVA	0-50kV	100mA	200mA
KV50-250	230V ±10%	12.5kVA	0-50kV	100mA	250mA
KV100-100	230V ±10%	11kVA	0-100kV	50mA	100mA

1.2 Front Panel Controls

1.2.1 Standard Units Without Timer

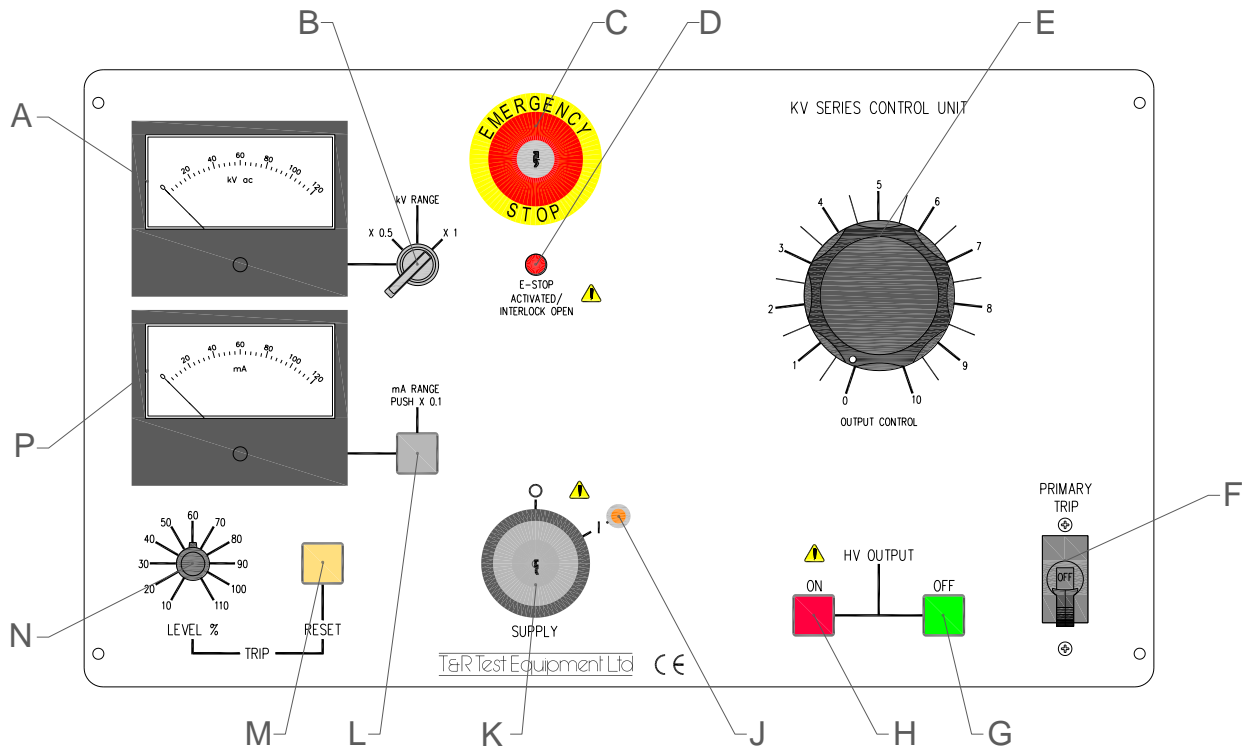

Figure 1.1 Control panel front panel layout

A	kV meter*	H	HV output on switch and indicator
B	kV meter range switch	J	Supply indicator
C	Emergency stop button	K	Supply on/off switch
D	E-stop/interlock reset button	L	mA meter range switch
E	Output control knob	M	Variable overload trip reset switch
F	Fixed overload circuit breaker	N	Variable overload trip level select
G	HV output off switch and indicator	P	mA meter*

* The meters shown are for a KV100-100

1.2.2 -T units With Test Timer

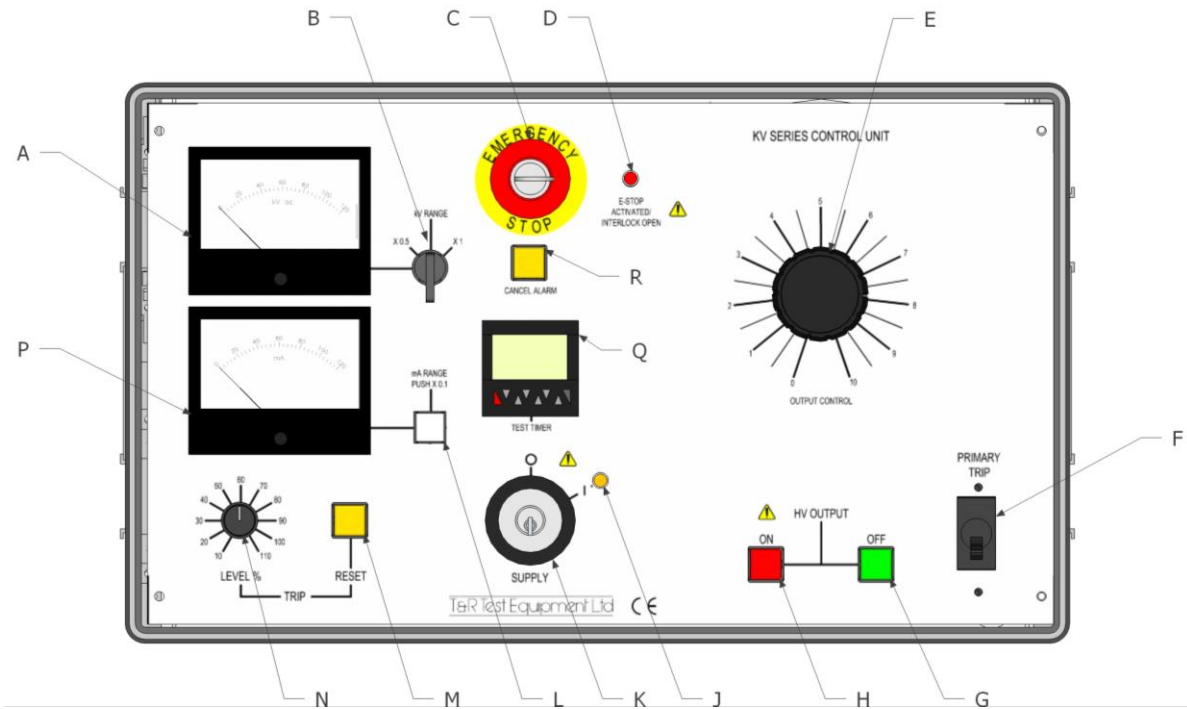

Figure 1.2 Control panel front panel layout (-T versions)

A	kV meter*	H	HV output on switch and indicator
B	kV meter range switch	J	Supply indicator
C	Emergency stop button	K	Supply on/off switch
D	E-stop/interlock reset button	L	mA meter range switch
E	Output control knob	M	Variable overload trip reset switch
F	Fixed overload circuit breaker	N	Variable overload trip level select
G	HV output off switch and indicator	P	mA meter*
Q	Test timer	R	Cancel timer alarm

* The meters shown are for a KV100-100-T

1.3 Rear Panel Connections

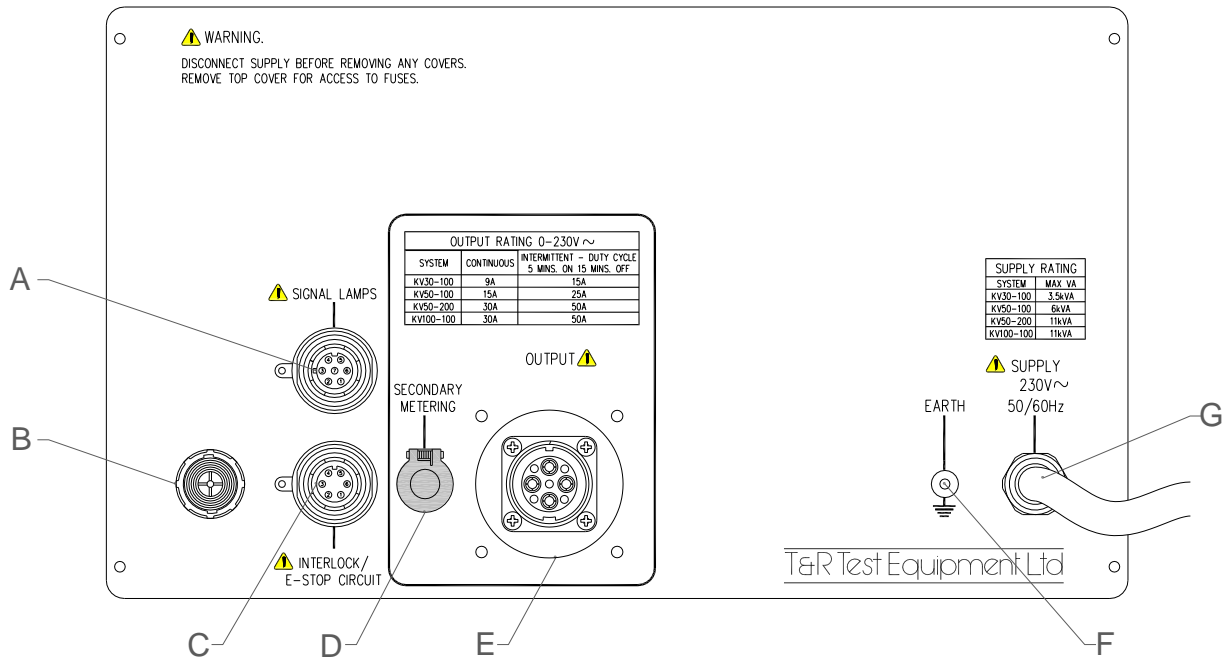

Fig. 1.3 Rear panel connections
Note: KV30-100 has different style connector

- | | | | |
|---|---|---|---|
| A | Signal beacons & earthing mechanism control outputs | E | Output to HV transformer
Note: KV30-100 fitted with 3 pin connector. |
| B | Contactor fault alarm sounder | F | Main earth terminal |
| C | Interlock & emergency stop circuit inputs | G | Mains supply lead |
| D | HV transformer voltage & current metering inputs | | |

1.3.1 Alarm Sounder

The control unit switches its output on using two independent safety contactors, connected in series. Mechanically linked auxiliary contacts on these devices are used to monitor the status of the main contacts. If a condition is detected where either of the contactors remains closed when it is switched off (e.g. due to a welded contact), the other contactor will be disabled and the alarm will sound. Further operation of the unit will not be possible until the fault is rectified.

1.3.2 Signal Beacons

Connector A in Fig. 1.3 provides for the addition of green and red signal beacons (230V) which indicate the operational status of the equipment (in accordance with EN50191). Fig. 1.4 shows the general arrangement.

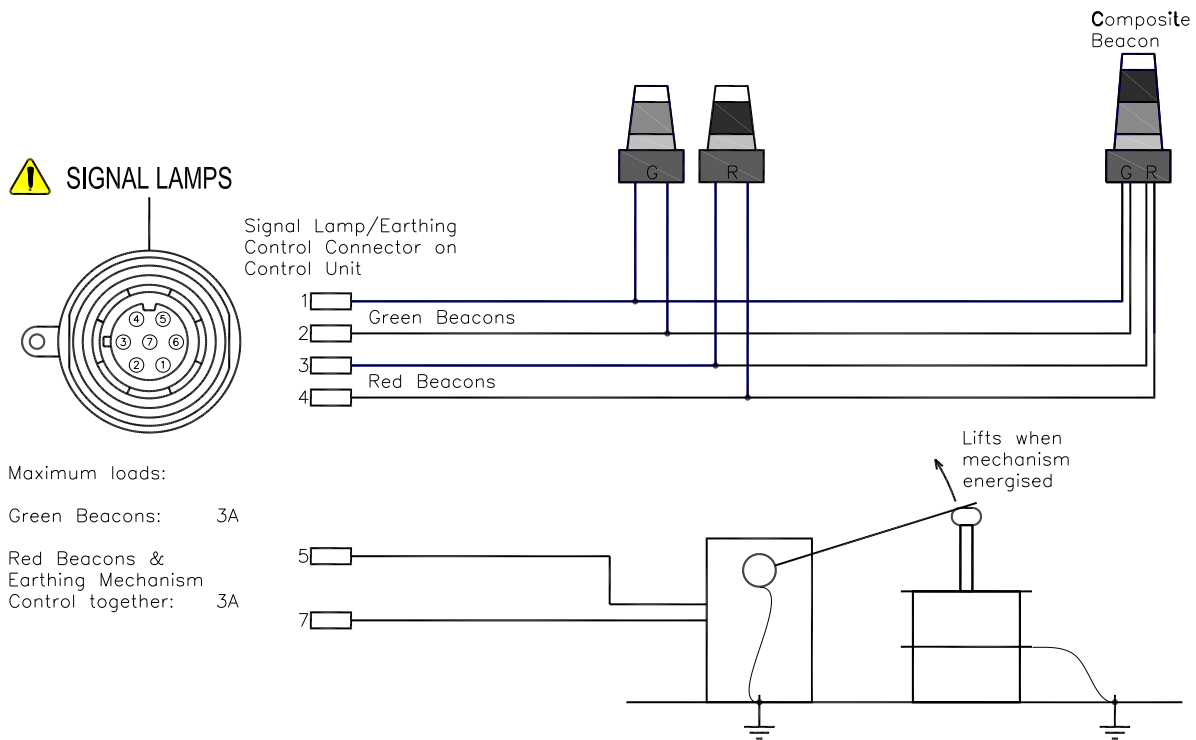

Fig. 1.4 Signal lamps and earthing mechanism arrangement

The **green** signal lamps are illuminated when the mains supply to the unit is on, and the key switch on the front panel (item K in Fig. 1.1) is off (**ready for operation**).

The **red** signal lamps are illuminated when the key switch is on, all interlock switches closed, all emergency stop buttons released and the interlock circuit reset by pressing the front panel button (item D in Fig. 1.1) (**ready to switch on**). The red lamps will remain illuminated when the output voltage is switched on (**in operation**). They will not be extinguished until an emergency stop or interlock switch is opened, or the control unit is switched off with the key switch. See the section Optional Accessories for information on a suitable connector.

1.3.3 Earthing Mechanism Control Output

Connector A also provides a 230V output which may be used to control an automatic earthing mechanism. The output will be on whenever the unit is **ready to switch on** or **in operation** (when the **red** signal lamp is on). This output can be used to trigger the removal of an automatic earthing mechanism.

1.4 Output Voltage Control

The output is controlled from the output control located on the front panel of the control unit. To increase the output voltage the knob is turned in a clockwise direction.

Note:- The output cannot be energised unless the output control is at zero, i.e. fully anticlockwise.

1.5 Overload Protection

The equipment is fitted with fixed and variable overload protection circuits as standard.

1.5.1 *Fixed Overload*

The fixed overload protection system senses any rapid increase in the load current which exceeds approximately 120% of the full load current in the high voltage circuit. The circuit will respond more quickly to low impedance faults.

1.5.2 *Variable Overload*

The variable overload protection system senses current changes in the high voltage circuit. The trip level is adjusted by means of a selector switch on the front panel of the control unit. The switch allows the level to be adjusted from 10-110% of normal full current in eleven steps. The circuit will activate when the load current exceeds that set by the trip level selector switch. The circuit will respond to more slowly changing levels of load current.

IMPORTANT NOTE:

The variable overload trip circuit does not limit the output current on short circuit.

1.6 Metering

The KV mk2 series range use a tap on the secondary of the HV transformer for voltage metering. This can be more accurate than primary metering, although capacitive loads will still cause the meter to read low.

If very accurate kV metering is required, it is necessary to use an external HV divider.

All of the units use moving coil analogue meters.

1.6.1 Metering Ranges

Unit	Voltmeter FSD		mA meter FSD	
	X1	X0.5	X1	X0.1
KV30-100	40kV	20kV	120mA	12mA
KV50-100	60kV	30kV	120mA	12mA
KV50-200	60kV	30kV	240mA	24mA
KV50-250	60kV	30kV	300mA	30mA
KV100-100	120kV	60kV	120mA	12mA

1.6.2 **IMPORTANT NOTE - Metering Connections**

It is essential that the metering lead from the high voltage transformer to the control unit is connected in circuit. If this lead is not connected, the metering on the control unit will not function and the variable overload trip will not function.

1.7 Test timer (-T suffix units only)

The test timer fitted to -T units may be pre-set with a test time in hours, minutes and seconds. The timer counts down when the output is switched on and an alarm sounds when the timer reaches zero.

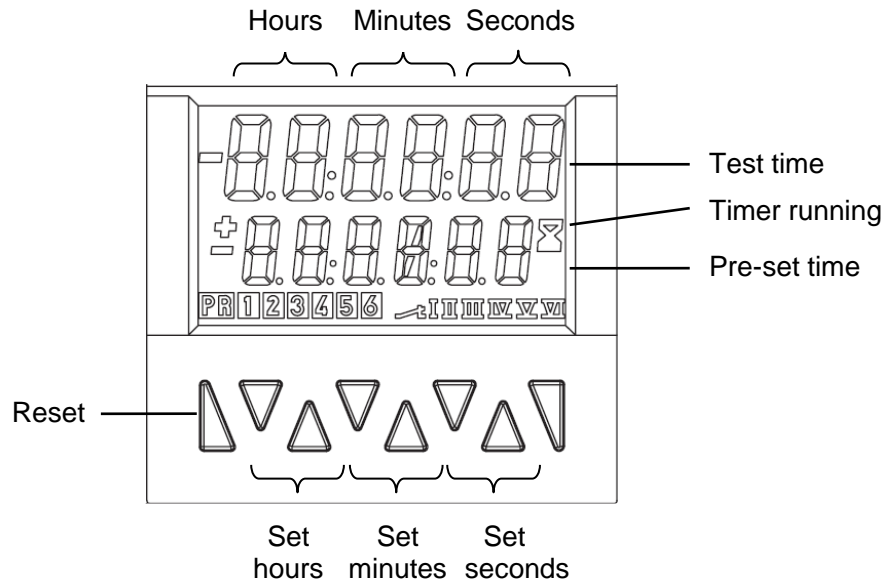

Fig. 1.5 Test timer

1.7.1 Setting the Test Time

Set the test time using the six central triangular buttons on the front of the timer. Each button sets one digit of the timer. The timer displays the time in the format hh:mm:ss in hours, minutes and seconds. When the test time has been set, press the Reset button on the timer twice to set the current test time to the pre-set time.

1.7.2 Starting the Timer

The timer automatically starts when the HV output is switched on. The timer counts down from the pre-set value to zero.

1.7.3 Resetting the Timer

The timer is automatically reset to zero when the HV output is switched off.

1.7.4 Cancelling the Alarm

The alarm is cancelled by pressing the CANCEL ALARM button or switching off the output. If the alarm is cancelled while the output is still switched on the time is reset to the pre-set value and the timer will start counting down again.

1.7.5 Disabling the Timer

It is not possible to disable the timer, but if you do not wish to use the test timer, set the test time to a large value (e.g. 10 hours). The timer will still run, but will not affect the test.

1.8 Interlock Circuits

1.8.1 Zero Voltage Interlock

The equipment is fitted with a zero volt interlock system on the output voltage control. This interlock prevents the output being energised unless the output control is in the zero position.

1.8.2 External Interlock/Emergency Stop Circuit

The equipment is fitted with an external, dual channel interlock system with safety monitoring. The external circuit is implemented as a chain of switches, e.g. door or cage switches and emergency stop buttons, each having a pair of normally closed contacts (i.e. contacts open when an emergency stop button is pressed or an interlocked enclosure gate is opened). Fig. 1.6 shows the general arrangement.

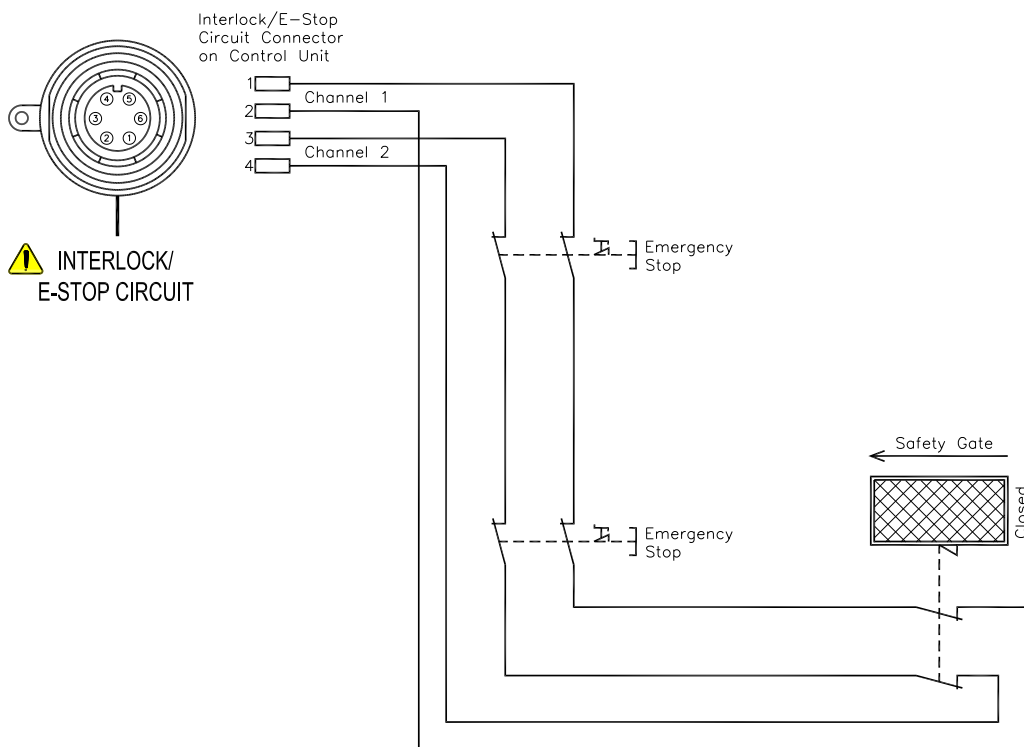

Fig. 1.6 External interlock/emergency stop circuit arrangement

To ensure the maximum level of safety, and to enable fault detection in the external wiring, it is essential to use both channels and dual contact switches as shown.

Upon activation of any of the external switches, the output of the Control Unit will switch off and the reset button/indicator on the Control Unit (item D in Fig. 1.1) will illuminate. Before the output can be switched on again, all interlock switches must be closed, emergency stop buttons released and the interlock reset button pressed.

In case of a fault in the external circuit (short between switch channels etc.) the output will again be switched off and disabled. It will then not be possible to reset the interlock circuit until the fault has been rectified.

1.9 Output Configuration

Note: The circuits shown below show a simplified arrangement. A full circuit diagram of the unit may be found at the rear of the manual.

1.9.1 HT Transformer Terminals

Screen 1	Screen between primary winding and core
Screen 2	Screen between primary and secondary windings. Note: KV30-100 has one screen.
HV Start	Earthy end of secondary (HV winding)
HV Earth	Transformer earth terminal
100V Tap	100V tap on secondary winding

In normal use, the HV earth, screen 1 and screen 2 terminals must be linked together.

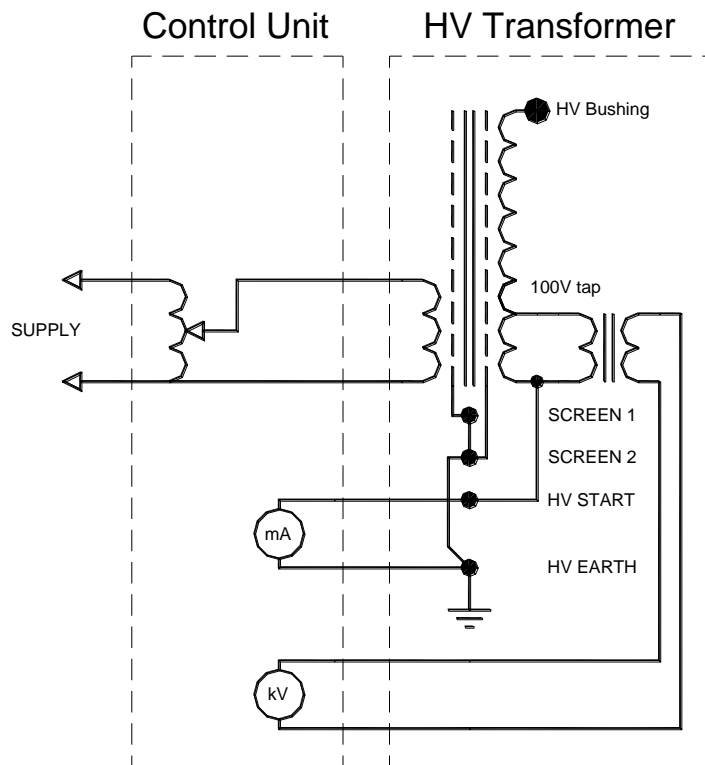

Figure 1.7 Secondary tap metering output configuration

1.10 Construction

1.10.1 Control Unit

The control unit is housed in aluminium case. All controls and metering functions are located on the front panel. All power and interconnecting outputs are located on the rear panel.

1.10.2 HV Transformer

The high voltage transformer is housed in an indoor type sheet steel tank of all welded construction. The tank is fitted with an oil drain plug, free air breather, lifting eyes, rating plate, earthing terminal and an initial filling of insulating oil to BS 148.1972.

The high voltage end the winding is terminated in an indoor type bushing mounted on the transformer cover.

2. OPERATION

2.1 Safety

The outputs from the KV series are extremely dangerous, and if used incorrectly could be fatal. The unit must only be installed, operated, and maintained by suitably qualified and trained personnel.

It is essential to follow accepted safety procedures and local health and safety regulations and guidelines when installing and operating high voltage equipment. A risk assessment should be undertaken on both the installation and the working procedures to ensure the safety of test personnel and all other personnel.

2.1.1 *Installation*

2.1.1.2 *Test Area*

The unit must be installed in a suitable high voltage test area completely enclosed by walls or some type of physical barrier. Appropriate controls and safety measures must be applied to this area including interlocks connected to the supply or HV unit interlock to ensure that the unit cannot be switched on unless the area is secure. Refer to EN50191:2001 for further details of suitable test enclosures. The test area must also be identified with suitable signs.

2.1.1.3 *Mains supply*

The unit must be connected to a suitable supply via an approved and suitably rated mains connector with earth connection. Please refer to section 1.1 for the supply requirements for each unit.

2.1.1.4 *Earthing*

Particular attention must be made in earthing the equipment, and all earth connections must be made with substantial conductors with secure joints.

The earth connection on the HV transformer must be connected to a suitable low impedance earth. It is also advisable to connect the control unit earth terminal to the local earth.

The earth return from the test object must also be made with a suitable conductor back to the earth point on the HV transformer (see figure 2.1).

All earth connections must be able to withstand the largest fault current that may be encountered in the system.

2.1.2 *Operation*

It is essential that safe working practices are maintained when conducting high voltage testing. Safe working procedures must be implemented to accepted standards (e.g. EN50191:2001 in the EU).

2.1.2.1 *Interlocks*

The unit is provided with a dual channel external interlock circuit that may be used to link to interlock switches on the high voltage test area. The test area must be interlocked.

An interlock should be considered to be a safety back-up feature. An interlock should not be regarded as a substitute for adequate safety rules and proper operator vigilance.

2.1.2.2 *Grounding of the High Voltage Output*

A temporary ground should be applied to the high voltage output when the circuit has been de-energised using the earth stick provided. When connections are made or disconnected, the circuit either side of the connection should be grounded first. Extra earth sticks are available from T&R Test Equipment as an optional accessory. Alternatively an automatic earthing system can be implemented under the control of the output provided (refer to section 1.3.3).

If the test circuit includes capacitors, each capacitor should be grounded separately before connections are made or broken. In the case of capacitors connected in series, the intermediate terminals should also be grounded.

It is good practice for all capacitive devices to remain short-circuited when not in use.

2.1.2.3 *High Voltage Connection*

The HV connection to the test object must be made securely, and suitable stress relief components should be used where required to keep electrical stresses within acceptable limits. The KV series are designed to be used with an air-insulated output conductor. No HV connection lead is supplied with the KV series units.

2.1.2.4 *High Voltage Output Clearances*

The high voltage output from the unit is from a bushing, and adequate clearances (distances between objects through the air) must be maintained between the following parts and any other conducting object (whether earthed or not):

- HV bushing
- Wiring connected to HV bushing
- Non-grounded parts of test object

Any part of the test object not connected to earth should be considered live at the test voltage.

The clearances required when high voltage testing may be split into two groups – functional clearances and safety clearances.

- Functional clearances relate to the clearances entirely within the test enclosure to ensure that there is no risk of breakdown.
- Safety clearances are the clearances required to ensure the safety of personnel at all times, and relate to clearances that may affect the test enclosure or personnel outside the test enclosure. Safety clearances will always be higher than functional clearances. Safety clearances may be obtained from BSEN50191:2001.
- EN50191 defines prohibition zones for high voltage, describing a volume around high voltage parts that personnel or their tools must not be able to reach. The prohibition zones

also provide a conservative functional clearance to earth for high voltage components in the test area.

Particular attention should be paid to clearances between any parts of the test object at test voltage potential and the test enclosure or barriers. Refer to EN50191:2001 and local safety standards for details of the safety clearances required.

Unit type	Maximum voltage	Prohibition zone /functional clearance
KV30-100	30kVac	170mm
KV50-100, KV50-200, KV50-250	50kVac	280mm
KV100-100	100kVac	560mm

Safety clearances from prohibition zones to barriers are shown below. These are simplified clearances based on a 1.2m high barrier (different arrangements allow this value to be reduced). Always check the latest version of EN50191 for clearances applicable to your test area and test.

Unit type	Maximum voltage	Horizontal clearance from prohibition zone to barrier
KV30-100	30kVac	1.4m
KV50-100, KV50-200, KV50-250	50kVac	1.4m
KV100-100	100kVac	1.4m

2.2 Connections

Before making any connections please ensure that you are aware of all hazards relating to the system and environment in which it is operating.

The test object must be isolated, proved to be dead and earthed before any connections are made.

Ensure that the system is properly earthed - connect a substantial earth lead of low resistance and impedance from a reliable efficient earth to the earth terminal on the high voltage transformer and the earth terminal on the control unit.

Connect the control unit to the HV transformer with the supplied power and metering leads.

Connect a suitable conductor from the high voltage transformer bushing to the test object. Please note that an HV connection lead is not supplied with the unit. The unit is designed to be used with an air-insulated HV connection (such as tinned copper wire or copper tubing of an appropriate diameter). It is important to ensure that adequate clearances to earthed objects are maintained from the output terminal, HV connection and test object. The HV conductor must be supported securely.

Connect a suitable conductor from the test object earth to the earth terminal on the high voltage transformer (see figure 2.1).

The interlock connections are not shown in figure 2.1.

Note: HV connection lead and earth lead not supplied with unit.

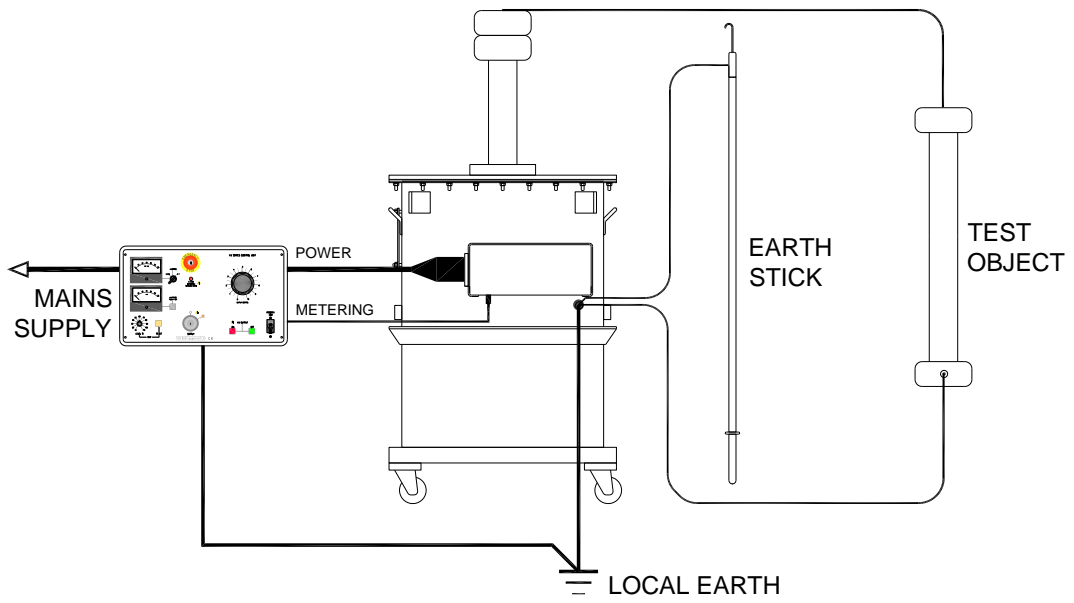

Figure 2.1 KV Series connections (KV100-100 shown)

Note: HV connection lead and earth lead not supplied with unit.

2.3 Method of Operation

Before operating the unit please ensure that you are aware of all hazards relating to the system and environment in which it is operating, and that you have complied with all necessary safety regulations and precautions.

Remove the key from the mains on/off switch before making any connections. This will ensure that the unit is off because the key may only be removed in the off position. The key is trapped in the on position.

Connect the equipment as described in section 2.2, keeping the test object earthed at all times using the earth stick provided.

Remove the earth connection from the test object before applying the test voltage to the test object.

Connect the mains supply to the unit.

Switch the main power key switch on. This will cause the following indicators to illuminate:

- Mains on indicator
- HV off green indicator in HV off pushbutton
- Variable overload indicator in variable overload reset switch
- Interlock/E-stop reset switch

Press the variable overload reset switch to reset the trip. Ensure that all external interlocks are closed and the front panel Emergency stop and any external E-stops are released. Press the interlock/E-stop reset switch to arm the circuit.

Set the desired kV meter range, and set the variable overload to the desired trip level.

Before commencing testing set the regulator to the fully anti-clockwise (minimum) position.

Press the HV output on pushbutton. The HV output off (green) indicator will extinguish and the HV on indicator (red) will illuminate.

The HV output level can now be increased to the desired level.

In the event of a test object failure the HV output will be automatically switched off by the protection system.

When the test is completed, turn the regulator control knob fully anti-clockwise and switch off the HV output and then the main supply.

Re-apply the earthing stick to the test object.

Before disconnecting the test object ensure the HV connection is grounded using the earthing stick provided.

3. MAINTENANCE



WARNING

Maintenance and repair of the KV series must only be carried out by suitably qualified and trained personnel. Potentially lethal voltages are present inside the unit and on the output leads.

Ensure that the unit is disconnected from the mains before removing any covers.

3.1 Output Control Variable transformers

It is advisable to check the carbon brush on the variable transformers for signs of wear on a regular basis. To gain access to the variable transformers remove the top cover of the unit (secured by four screws - two in each side of the case).

Replacement brushes are available from T&R Test Equipment.

3.2 HV Output Transformer

The HV transformer oil level should be checked every time the transformer is used. A sample of oil should be taken every 2 years for chemical and electrical analysis. The top cover and bushing must be kept free of dirt and dust and must be wiped regularly with a damp cloth. Do not use solvent cleaners, and ensure that the top cover and bushing are totally dry before operating the unit.

4. ACCESSORIES

4.1 Standard Accessories

Spare fuses supplied

- 1 off 4amp, Bussmann Ref. NSD4
- KV30-100: 1 off 25A Bussmann Ref. AA025
- KV50-100: 1 off 25A, Bussmann Ref. AA025
- KV50-200: 1 off 50A, Bussmann Ref. BA050
- KV50-250: 1 off 63A, Bussmann Ref. BA063
- KV100-100: 1 off 50A, Bussmann Ref. BA050

The following items are provided with the equipment:

- 2 keys for mains ON/OFF switch.
- 2 keys for front panel Emergency stop release.
- External interlock connecting plug, Bulgin Ref. PX0739/P (RS Stock No. 483-950)
- 5 metre power interconnecting lead.
- 5 metre screened interconnecting lead.
- Earthing stick.
- Operating & Maintenance Manual.

4.2 Optional Accessories

To connect to external signal beacons and/or automatic earthing controller, use a 7 way connector, Bulgin Ref. PX0745/P (RS Stock No. 275-5342)

5. OVERALL PERFORMANCE SPECIFICATION

5.1 Insulation resistance at 1000V DC

Not less than 10 megohms between mains input and frame.

5.2 Applied voltage test

2.5kV RMS for 1 minute between mains input and frame

5.3. Accuracy of instruments

kV meter:- DC moving coil (rectified AC) $\pm 2.0\%$ F.S.D

mA meter:- DC moving coil (rectified AC) $\pm 2.0\%$ F.S.D

Note:- Equipment with primary voltage metering, kV accuracy quoted for no-load.

5.4. H V Transformer

2.5kV RMS for 1 minute between primary and earth

2.5kV RMS for 1 minute between earthy end of secondary and earth

5.5. Complete Equipment

Flash-over tests

4 flash-overs direct to ground at 100% of normal output voltage

6. REVISION

Product: KV mk2 Series High Voltage AC Test System
File: OM0021.docx
Author: I Lake/P Clode

Issue / Date: 8 / 07/06/21
Modified By: G. Bond

Checked By: M Clancy	Date: 24/07/21
----------------------	----------------

Drawings :

001555 – KV100-100

001808 – KV30-100T